

SYNTHESIZED AM BROADCAST TRANSMITTER KIT



Ramsey Electronics Model No.

AM-25

Ever want to be your own disc jockey or talk show host ? Build and run your own AM broadcast station with this exciting kit ! The AM-25 transmitter offers a professional quality signal that is free from frequency drift and programmable to anywhere in the AM broadcast band !

- **Great for transmitting your tape deck, CD player, or voice throughout the house, yard, or car !**
- **Powerful enough for high school, college, or neighborhood radio station - in use the world over !**
- **Easily programmed via DIP switch to any clear channel on the AM broadcast band - from 540 to 1710 KHz.**
- **Operates on the same principle as the "big-boys", learn how commercial transmitters work as well !**
- **Superior performance - transmits up to 1/4 mile !**
- **Adjustable transmit power level, low pass filtered output.**
- **Unit runs on 9 - 12 volts DC.**
- **Handy information on FCC rules and antenna hints.**
- **Complete and informative instructions guide you to a kit that works the first time, every time - enhances resale value, too !**

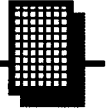

PARTIAL LIST OF AVAILABLE KITS:

RAMSEY TRANSMITTER KITS

- FM-10 FM Stereo Transmitter
- FM-1,2,4 FM Wireless Microphones
- PB-1 Telephone Transmitter
- AM-1 AM Transmitter

RAMSEY RECEIVER KITS

- FR-1 FM Broadcast Receiver
- AR-1 Aircraft Band Receiver
- SR-1 Shortwave Receiver
- AA-7 Active Antenna
- SC-1 Shortwave Converter

RAMSEY HOBBY KITS

- SG-7 Personal Speed Radar
- SS-70 Speech Scrambler
- SP-1 Speakerphone
- MD-3 Microwave Motion Detector
- PH-10 Peak hold Meter
- LC-1 Inductance-Capacitance Meter

RAMSEY AMATEUR RADIO KITS

- FX Series VHF and UHF Transceivers
- HR Series HF All Mode Receivers
- QRP Series HF CW Transmitters
- CW-7 CW Keyer
- PA Series VHF and UHF Power Amplifiers
- Packet Computer Interfaces
- QRP Power Amplifiers

RAMSEY MINI-KITS

Many other kits are available for hobby, school, Scouts and just plain FUN. New kits are always under development. Write or call for our free Ramsey catalog.

AM-25 Synthesized AM BROADCAST TRANSMITTER KIT INSTRUCTION MANUAL

Ramsey Electronics publication No. MAM-25 Revision 1.0

First printing: December 1996



COPYRIGHT ©1994 by Ramsey Electronics, Inc. 793 Canning Parkway, Victor, New York 14564. All rights reserved. No portion of this publication may be copied or duplicated without the written permission of Ramsey Electronics, Inc. Printed in the United States of America.

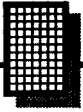

KIT ASSEMBLY AND INSTRUCTION MANUAL FOR

SYNTHESIZED AM TRANSMITTER AM-25

TABLE OF CONTENTS

Introduction to the AM-25.....	4
AM-25 Circuit Description	4
Schematic Diagram	7
Parts Layout Diagram	8
Parts List	9
Assembly Instructions	10
Frequency chart	18
Alignment Procedures	19
Troubleshooting	20
FCC Information	20
Antenna Experimenting	22
Ramsey Kit Warranty	23

RAMSEY

RAMSEY ELECTRONICS, INC.

793 Canning Parkway
Victor, New York 14564
Phone (716) 924-4560
Fax (716) 924-4555

INTRODUCTION

Many times we wish to be heard via wireless communications. Whether transmitting music or voice, what is required is a stable transmitter tunable to an unused frequency on the broadcast band. Here at Ramsey, we have produced several models of FM transmitters and an entry level AM transmitter. Recent requests for a synthesized AM type transmitter have been answered with this kit.

The Ramsey AM-25 transmitter is a true broadcast transmitter, which any person may build and use in accordance with the rules of one's national telecommunications authority. For U.S. residents, that authority is the Federal Communications Commission (FCC). The AM-25's low power broadcasting capabilities make it practical for many uses, but one should remember that this transmitter is definitely not a toy. We will refer to the FCC regulations frequently in this manual and provide you with some information necessary to enjoy the AM-25's capabilities in accordance with the law.

Typical uses for the AM-25 include:

- Student operated school radio stations.
- Re-broadcasting received audio for shortwave or HAM radio use.
- Listening aid for auditoriums, churches, or other events.
- Short range experimentation.

We think that you will be very pleased with the transmitting range, audio quality, and frequency stability of this build it yourself AM transmitter. If you follow our assembly instructions carefully and use your AM-25 in accordance with applicable FCC rules, a whole new world of sharing news, views, and music with friends and neighbors awaits you.

AM-25 CIRCUIT DESCRIPTION

Before we dive into the circuit description of the AM transmitter, first we'll describe exactly what we mean when we say "AM". An (A)amplitude (M)modulated signal is actually a combination of two signals. The high frequency carrier is the frequency that one will tune on the radio receiver's dial, from 530 to 1750 KHz. The modulation is the audio information that rides "on top" of the high frequency carrier, resulting in a changing of the level, or amplitude, of the output waveform. Take a glance at the schematic and follow along at how we produce this AM waveform.

The RF oscillator consists of Q4, Q6 and associated components. The frequency of operation is determined by selecting the proper values for L5, L7 and varactor diode D2. The Phase-Locked-Loop portion of the circuit controls the capacitance of the varactor diode to keep the frequency exactly as

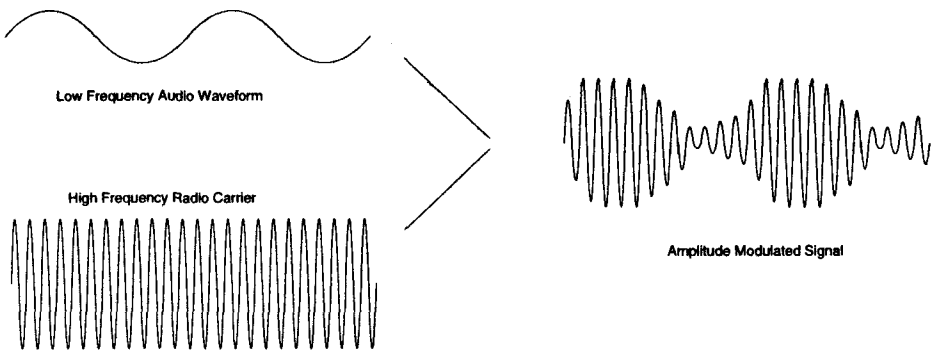

selected. We'll examine that in more detail later. A buffer amplifier, Q5 increases the output of the oscillator enough to drive final RF amplifier Q3.

The audio input path is routed from J2, the audio input source, to opamp U1 which both amplifies and level shifts the incoming signal. Transistors Q8, Q9 are used to increase the current output capacity of the opamp in order to modulate the final RF amplifier stage. These transistors are biased to be operating in the linear region with a no signal output level of exactly one-half the supply voltage as set by pot R23. The incoming audio signal is therefore amplified undistorted (for great sounding audio). The audio input level to the amplifier can be adjusted using R31, the input level adjustment.

Power FET transistor Q3, is the "power amplifier" section of the circuit. Its drain voltage is supplied through matching auto-transformer L4 from Q8 and Q9, thus producing an AM output waveform. This signal is then low pass filtered using C1 - C7 and inductors L1 - 3.

Notice that the audio information is applied at the power amplifier stage. This is referred to as "high level" modulation, and is commonly used for high power AM broadcast stations. The distinct advantage to this is that the RF amplifier need not be biased for linear operation, which is not only very inefficient but somewhat complicated also. It is much easier and cheaper to manufacture a linear amplifier for the relatively low frequency audio range, than to perfectly linearly amplify a low level AM RF waveform to a high power RF level. The main disadvantage of high level modulation is that the audio modulator's power must be half that of the final transmitter, not too tough for our low power kit, but try to imagine the amplifier for a 50,000 watt AM broadcast station! Boy, that audio amp would sure crank the 'ol car stereo!

It should also be stated that, due to the linear operation of the amplifiers in this circuit (transistors Q8 and Q9 biased partly "on"), this circuit will consume a fair amount of power. It is not recommended that a common rectangular 9V battery be used to power this kit. Instead, a battery "pack" consisting of eight 1.5 volt

cells, a 12V sealed battery, or other external 12V DC supply may be used.

The Phase-Locked-Loop portion of the circuit is responsible for maintaining the frequency of the transmitter. U2 is the brains of the whole circuit. This chip looks at the settings of each switch in the dip switch S1 and from this information, calculates the desired frequency. These switches are programmed in Binary, you simply add up the closed switch positions: 1, 2, 4, 8 all the way up to 128 to make any number between 0 and 255. The final output frequency will be the programmed number times 10 KHz. For the AM broadcast band, 540 - 1710 KHz, we'll only need to program between 54 and 171. For example, if a broadcast frequency of 550 KHz if desired, we'll need a programmed number of 55 (55 times 10 KHz equals 550 KHz). Closing switches 32, 16, 4, 2 and 1 all adds up to 55, our desired number. As another example, what would we need for 1520 KHz? Our desired program number is 152 and we'll have to close switches 128, 16, and 8 which adds up to 152! It really is quite easy and fun to find the right switches to close!

The phase locked loop (PLL) synthesizer IC takes the 10.24 MHz crystal frequency and divides it internally by 1024 to obtain a stable reference frequency of 10 KHz for the PLL's phase detector. U1 also takes the output frequency from the VCO (Voltage Controlled Oscillator) and divides it by a number that we'll call 'N'. N is the frequency data that was sent by U2, and N is always equal to the desired frequency in megahertz times 10.

Using the example from above, a frequency of 550 KHz gives an N of 55, so the frequency from the oscillator is divided by 55 and then compared with the reference frequency of 10 KHz. If the desired frequency is less than the reference frequency U2 increases the output voltage on pin 7. This increases the voltage across diode D2, a varactor diode. As the voltage across the varactor increases, it causes a decrease in capacitance (Increasing reverse bias essentially increases the distance between the capacitor's plates by increasing the depletion region in the diode ($C = kA/d$). The decrease in capacitance causes an increase in the VCO's RF frequency ($f = 1/\sqrt{2\pi(LC)^{1/2}}$), bringing the AM-25's output frequency back on frequency. If the desired frequency is higher than the reference, pin 7 is driven low. If the frequency is just right then pin 7 becomes a high impedance, basically disconnecting it from the circuit so it will cause no change in the voltage on D2. The voltage changes on pin 7 are filtered by R25, C26, R28, and C28 to provide a steady, noise free tuning voltage for D2. In this way the output frequency of the oscillator is "locked" to that desired by U2. When the frequency is locked, U2 will cause led D3 to be brightly lit. If D3 is dim or off there is a problem and the frequency is not locked. If the frequency starts to drift for any reason (such as a temperature change) then U2 instantly corrects the tuning voltage to bring it back to the proper frequency.

AM-25 SCHEMATIC DIAGRAM

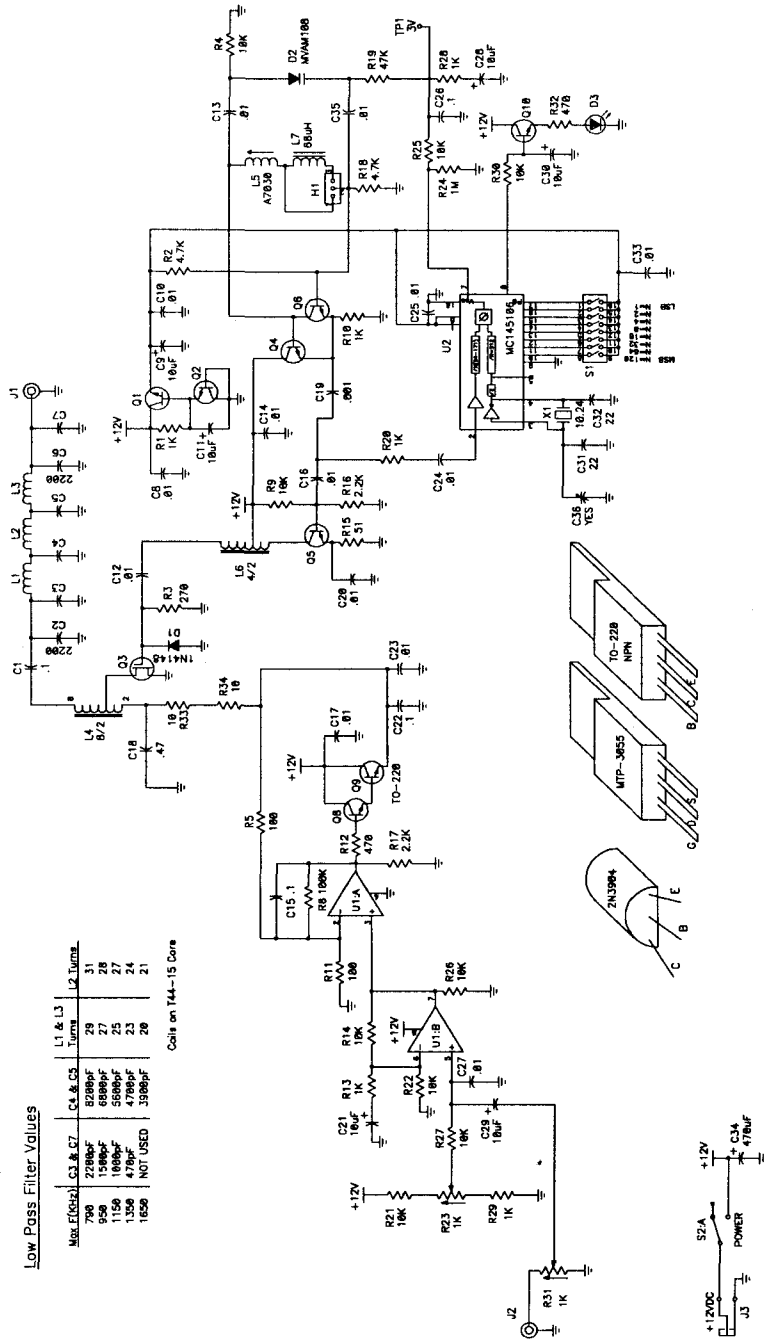

Low Pass Filter Values

	C3 & C7	C4 & C5	L1 & L3	L2 Turns
Max. Freq.	700	2280cf	8200cf	31
	950	1580cf	6800cf	27
	1150	1080cf	5600cf	25
	1350	470cf	4700cf	23
	1650	NOT USED	3500cf	20

Coils on T44-15 Core

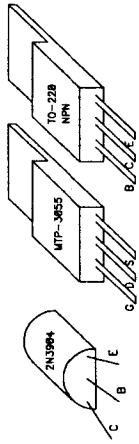

PARTS LIST

RESISTORS

- 2 10 ohm [brown-black-black] (R33,34)
- 1 51 ohm [green-brown-black] (R15)
- 2 100 ohm [brown-black-brown] (R5,11)
- 1 270 ohm [red-violet-brown] (R3)
- 2 470 ohm [yellow-violet-brown] (R12,32)
- 5 1K ohm [brown-black-red] (R10,13,20,28,29)
- 2 2.2K ohm [red-red-red] (R16,17)
- 2 4.7K ohm [yellow-violet-red] (R2,18)
- 10 10K ohm [brown-black-orange] (R1,4,9,14,21,22,25,26,27,30)
- 1 47K ohm [yellow-violet-orange] (R19)
- 1 100K ohm [brown-black-yellow] (R8)
- 1 1 Megohm [brown-black;green] (R24)
- 2 1K PC mount potentiometer [marked 102] (R23,31)

CAPACITORS

- 2 22 pF disc capacitors [marked 22 or 22K] (C31,32)
- 2 470 pF disc capacitors [marked 470 or 471] (C3,7)
- 2 1500 pF disc capacitor [marked .0015 or 152 or 1500K] (C3,7)
- 4 2200 pF disc capacitor [marked .0022 or 222 or 2200K] (C2,3,6,7)
- 2 3900 pF disc capacitor [marked .0039 or 392 or 3900K] (C4,5)
- 2 4700 pF disc capacitor [marked .0047 or 472 or 4700K] (C4,5)
- 2 5600 pF disc capacitor [marked .0056 or 562 or 5600K] (C4,5)
- 2 6800 pF disc capacitor [marked .0068 or 682 or 6800K] (C4,5)
- 2 8200 pF disc capacitor [marked .0082 or 822 or 8200K] (C4,5)
- 3 .001 μ F disc capacitor [marked .001 or 102] (C3,7,19)
- 13 .01 μ F disc capacitor [marked .01 or 103 or 10nF]
(C8,10,12,14,16,17,20,23,24,25,27,33,35)
- 4 .1 μ F disc capacitor [marked .1 or 104] (C1,15,22,26)
- 1 .001 μ F capacitor (C18)
- 6 10 μ F electrolytic capacitors (C9,11,21,28,29,30)
- 1 470 μ F electrolytic capacitor (C34)
- 1 65 pF trimmer capacitor (C16)

INDUCTORS

- 3 Toroid inductors [red ferrite core] (L1,2,3)
- 2 binocular toroid cores (L4,6)
- 1 68 μ H inductor [looks like a resistor with blue-gray-black bands] (L7)
- 1 metal can slug tuned variable inductor [marked A7030] (L5)

SEMICONDUCTORS

- 7 NPN transistors [marked 2N3904] (Q1,2,4,5,6,7,8,10)
- 1 TO-220 style NPN power transistor [marked TIP31] (Q9)
- 1 TO-220 style power FET [marked MTP-3055] (Q3)
- 1 1N4148 style glass bead diode (D1)
- 1 MVAM-108 varactor diode [looks like transistor with 2 leads] (D2)
- 1 Red LED (D3)
- 1 LM-358 8 pin dual opamp IC (U1)
- 1 MC-145106 PLL synthesizer IC (U2)

MISCELLANEOUS PARTS AND HARDWARE

- 1 10.24 MHz crystal (X1)
- 2 RCA type PC mount connectors (J1,2)
- 1 2.1mm power jack (J3)
- 1 DPDT pushbutton switch (S2)
- 1 8 position DIP switch (S1)
- 1 3 pin header strip (H1)
- 1 jumper block
- 1 AM-25 printed circuit board
- 1 "diddle stick" plastic alignment tool
- 2 TO-220 Heatsinks
- 80' enameled magnet wire
- 2 4-40 x 1/4 screw
- 2 4-40 kepnut

ASSEMBLY INSTRUCTIONS

There are numerous solder connections on the AM-25 printed circuit board. Therefore, PLEASE take us seriously when we say that good soldering is essential to the proper operation of your transmitter!

- Use a 25-50 watt soldering pencil with a clean, sharp tip.
- Use only rosin-core solder intended for electronics use.
- Use bright lighting, a magnifying lamp or bench-style magnifier may be helpful.
- Do your work in stages, taking breaks to check your work. Carefully brush away wire cuttings so they don't lodge between solder connections.

We have a two-fold "strategy" for the order of the following kit assembly steps. First, we install parts in physical relationship to each other, so there's minimal chance of inserting wires into wrong holes. Second, whenever possible, we install in an order that fits our "Learn-As-You Build" Kit building

philosophy. This entails describing the circuit that you are building, instead of just blindly installing components. We hope that this will not only make assembly of our kits easier, but help you to understand the circuit. For each part, our word "Install" always means these steps:

1. Pick the correct part value to start with.
2. Insert the part, oriented correctly, into its holes in the PC-board.
3. If helpful, gently BEND the part's wire leads or tabs to hold it into place, with the body of the part snugly against the top side ("component side") of the PC-board. The top side is the side that does not contain metal traces, but does have an outline of each part printed on it.
4. Insert it into the correct PC board location.
5. Orient it correctly, follow the PC board drawing and the written directions for all parts - especially when there's a right way and a wrong way to solder it in. (Diode bands, electrolytic capacitor polarity, transistor shapes, dotted or notched ends of IC's, and so forth.)
6. Solder all connections unless directed otherwise. Use enough heat and solder flow for clean, shiny, completed connections.
7. Trim or nip all excess wires extending beyond each solder connection, taking care that wire trimmings do not become lodged in PC-board solder connections.

Now, let's get building!

Since you may appreciate some "warm-up" soldering practice as well as a chance to put some "landmarks" on the PC board, we'll first install some "hardware" components. This will also help us to get acquainted with the up - down, left - right orientation of the circuit board. Remember that the components will be mounted on the "component" (printed) side of the circuit board and then soldered on the "solder" (foil) side of the circuit board.

1. Install DPDT switch S2. Position it so that the plunger of the switch extends over the edge of the PC board. Be sure to push the switch flat to the circuit board. Solder all six connections.
2. Install RCA phono jacks J1 and J2. These connectors will "snap" into place before soldering. Don't be afraid to completely solder all three

ground connections as these will also limit the "stress" on the input and antenna connections.

- 3. Install the 2.1 mm power connector in the J3 position.

We'll now begin to construct the RF oscillator section of the AM-25. Be sure to mount the components as close as possible to the PC board to avoid "radiating" any unwanted signals due to long lead lengths.

- 4. Install L5, the slug tuned inductor. Solder all 7 tabs.
- 5. Install L7, a 68 uH inductor, it looks like a resistor with color bands on it, blue-gray-black.
- 6. Install C35, .01 μ F [marked .01 or 103 or 10 nF].
- 7. Install H1, the 3 pin header strip. You will later place a jumper block over a pair of pins depending upon which portion of the AM band you wish to transmit on.
- 8. Install R18, 4.7K ohm [yellow-violet-red].
- 9. Install R19, 47K ohm [yellow-violet-orange].
- 10. Install R28, 1K ohm [brown-black-red].
- 11. Install D2, MVAM-108 varactor diode. This part looks like a transistor with only two leads, pay attention to orienting the flat side correctly. A varactor diode acts like a voltage variable capacitor. In this case we use D2 to control the frequency of our oscillator and the PLL IC chip will orchestrate it all to maintain frequency exactly as programmed.
- 12. Install C13, .01 uf disc capacitor [marked .01 or 103 of 10 nf].
- 13. Install C14, another .01 uf disc capacitor.
- 14. Install jumper, JMP2. Simply use a small scrap of component lead wire bent into a 'U' shape. Jumpers act as electronic bridges crossing over circuit traces below.
- 15. Install Q6, a 2N3904 NPN transistor. When installing Q6, observe correct placement of the flat side. Press the transistor snugly into the PC board so that only a minimum amount of wire lead is exposed above the board. In soldering, do not be afraid of using enough heat to make a good solid connection.
- 16. Install Q4, another 2N3904 NPN transistor. These two transistors comprise the carrier oscillator for your transmitter.
- 17. Install R10, 1K ohm [brown-black-red].
- 18. Install R4, 10K ohm [brown-black-orange].
- 19. install C28, 10 μ F electrolytic capacitor. Electrolytic capacitors are polarized with a (+) and a (-) lead and must be installed in the correct orientation. Ordinarily, only the negative side is marked on the capacitor body with a dark band and the (-) sign clearly shown, while PC boards

will usually show the (+) hole location. Use care to ensure proper polarity.

- 20. Install C18, .47 μ F disc capacitor [marked .47 or 474].
- 21. Install R33, 10 ohm [brown-black-black].
- 22. Install R34, another 10 ohm [brown-black-black].
- 23. Install C26, .1 μ F disc capacitor [marked .1 or 104].
- 24. Locate a 1/2 inch long piece of scrap component lead. Install it into the black hole near trimmer capacitor C16. Leave about 1/2" standing up from the PC board, this wire point, which we will call TP1, will provide a convenient point for you to connect a meter probe.

You have just completed most of the RF carrier oscillator. Take a moment now to recheck you work for clean, shiny solder connections. Resolder any connections that are less than perfect.

We'll get back to building now, starting with the PLL circuitry.

- 25. Install U2, MC145106 PLL IC chip. Pay close attention to the notched end of the IC package, it must be oriented exactly as shown on the PC board or else! Ensure that all pins fit fully through the PC board and are securely soldered.
- 26. Install R30, 10K ohm [brown-black-orange].
- 27. Install R32, 470 ohm [yellow-violet-brown].
- 28. Install Q10, 2N3904 transistor. Be sure to orient it correctly! See the parts diagram for correct orientation.
- 29. Install Q2, another 2N3904 transistor, watch that flat side.
- 30. Install Q1, yet another 2N3904 transistor. The 2N3904 is one of the most common NPN silicon transistors ever made, in fact, one factory that I visited in Korea manufactured over 50 million of them per month!
- 31. Install R1, 10K ohm [brown-black-orange].
- 32. Install C11, a 10 μ F electrolytic capacitor, watch that polarity!
- 33. Install C10, .01 μ F disc capacitor [marked .01 or 103 or 10nF].
- 34. Install C8, another .01 μ F disc capacitor.
- 35. Install C9, 10 μ F electrolytic capacitor, observe polarity.
- 36. Install jumper wire, JMP4.

The last few parts formed a simple regulated power supply for the RF oscillator. A neat trick is the use of a reversed biased transistor as a zener diode - take a look at Q2, see how its base and collector are shorted together. Q2 makes a neat 6 - 7 volt zener!

- 37. Install C30, 10 μ F electrolytic capacitor, watch polarity.
- 38. Install JMP1 using a scrap piece of component lead wire.

- 39. Install R24, 1Meg ohm [brown-black-green].
- 40. Install R25, 10K ohm resistor [brown-black-orange].
- 41. Install C32, 22 pf disc capacitor [marked 22].
- 42. Install C31, the other 22 pf disc capacitor.
- 43. Install C24, .01 μ F disc capacitor [marked .01 or 103 or 10nF].
- 44. Install X1, the 10.24 MHz quartz crystal. Inside this metal can is a piece of synthetic quartz that has been precisely ground to vibrate precisely at 10.24 million times per second, very similarly to a mechanical tuning fork!
- 45. Install C25, .01 μ F disc capacitor [marked .01 or 103 or 10nF].
- 46. Install S1, the 8 position DIP switch, it is not important that you orient it in any direction, just be sure all pins fit fully through the PC board and are securely soldered. You will select your radio channel frequency by setting the little switch levers on the switch package.
- 47. Install C33, .01 μ F disc capacitor [marked .01 or 103 or 10nF].
- 48. Install R2, 4.7K ohm [yellow-violet-red].

That completes most of the PLL control circuitry of your transmitter. Now is a good time to check your work for any unsoldered connections or other mishaps. Later stages of the transmitter require extra care, so better to catch errors now rather than later.

- 49. Install C19, .001 μ F disc capacitor [marked .001 or 102].
- 50. Install R20, 1 K ohm [brown-black-red].
- 51. Install C16, 65 pF trimmer capacitor. Don't use too much heat as you can melt the plastic parts of the capacitor.
- 52. Install R9, 10K ohm [brown-black-orange].
- 53. Install Q5, another 2N3904 transistor.
- 54. Install C20, .01 μ F disc capacitor [marked .01 or 103 or 10nF].
- 55. Install R15, 51 ohm [green-brown-black].
- 56. Install R16, 2.2K ohm [red-red-red].
- 57. Install R3, 270 ohm [red-violet-brown].
- 58. Install C12, .01 μ F disc capacitor [marked .01 or 103 or 10nF].
- 59. Install D1, 1N4148 style glass bead diode, be sure to correctly orient the banded end of the diode as shown on the PC board.
- 60. Install C1, a .1 μ F disc capacitor [marked .1 or 104]. Watch so you don't confuse this capacitor with one of the more common .01 μ F types!
- 61. Install C2, 2200 pF disc capacitor [marked .0022 or 222 or 2200K].
- 62. Install C6, another 2200 pF disc capacitor.

This completes all of the transmitter RF portion except for the low-pass filter section and the 'binocular' shaped inductors L4 and L6. Let's get busy winding these inductors.

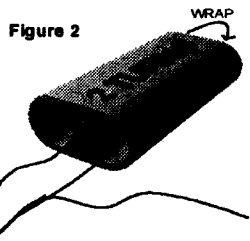
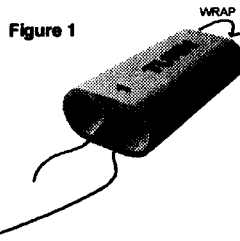

- Winding L4. Locate one of the binocular ferrite cores and the enameled magnet wire. We will talk about winding complete turns through the core, a complete turn is a full wire course through one hole in the core and back out through the other hole.
- 63. Cut a length of wire 18 inches long and following the diagram shown, wind 2 complete turns through the core and form a loop 3/4 " long.
- 64. Twist this loop fairly tight and continue winding another 8 complete turns through the core. Leave this wire end longer than the first wire, in this way we will have indicated that this is the side of the inductor that has 8 turns. If you wish, you can play it safe and color this wire with a black marker to really make it stand out.
- 65. Tin the ends of the wires on L4. Tinning means to 'burn' off the enamel insulation from the ends of the wire and to apply a coat of solder to the wire to allow a good solder connection. Simply puddle some solder on the end of your soldering iron and sit the wire in the hot puddle. You'll see the insulation burn off and a nice coating of solder attach to the copper wire under the enamel insulation. Gosh, it takes longer to explain than to do it!
- 66. Position the wire ends so that the three wires are in line with the twisted wire pair in the middle.
- 67. Install L4, paying attention to putting the 8 turn wire end into the PC board hole nearest C1. The twisted wires go in the center hole and the remaining wire which was 2 turns goes into the hole near C18. *It is vitally important that you properly install this part!*
- 68. Winding L6. This inductor is similar to L4, but has a different amount of turns. *short wire LONG*
- 69. Cut a length of wire 12 inches long and winding like you did before, wind 2 complete turns through the core and form a loop 3/4 " long.
- 70. Twist this loop fairly tight and continue winding another 4 complete turns through the core. Once again, leave this wire end longer than the first wire to indicate that this is the side of the inductor that has 4 turns. The marker trick is OK to use here too.
- 71. Tin the wire ends and line them up as you did before with the twisted pair in the middle.

72. Install L6, the 4 turn end installs into the hole near L5, the twisted pair into the center hole and the 2 turn end faces R16.

Just what are these inductors? The inductors you just wound are called broadband matching inductors. They act as impedance matching devices, similar to a transformer. L4, for example has a 4:1 turns ratio and will transform the low impedance output of Q3 up by 16 times. This is because the square of the turns ratio is equal to the ratio of impedances.

Now let's move over to the audio section.

73. Install U1, LM358 opamp. Be sure all pins are through the PC board and that the notched or marked end is positioned as shown.
74. Install R26, 10K ohm, [brown-black-orange].
75. Install R17, 2.2K ohm [red-red-red].
76. Install R11, 100 ohm [brown-black-brown].
77. Install C27, .01 μ F disc capacitor [marked .01 or 103 or 10nF].
78. Install C23, another .01 μ F disc capacitor.
79. Install C15, .1 μ F disc capacitor [marked .1 or 104].
80. Install R12, 470 ohm [yellow-violet-brown].
81. Install R8, 100K ohm [brown-black-yellow].
82. Install R5, 100 ohm [brown-black-brown].
83. Install JMP3 using a scrap component lead wire.
84. Install Q8, 2N3904 transistor, observe placement of the flat side.
85. Install C17, .01 μ F disc capacitor [marked .01 or 103 or 10nF].
86. Install C22, .1 μ F disc capacitor [marked .1 or 104].
87. Install C34, the large 470 μ F electrolytic capacitor. Be especially careful to observe correct polarity when installing this part, if installed with polarity reversed, it can explode. Believe me, that'll get your attention!
88. Install R21, 10K ohm [brown-black-orange].
89. Install R23, one of the small yellow trimmer pots. Be sure it is seated fully on the board before soldering.
90. Install R14, 10K ohm [brown-black-orange].
91. Install R27, another 10K ohm resistor [brown-black-orange].
92. Install C29, 10 μ F electrolytic capacitor, observe correct polarity.
93. Install R31, the other yellow trimmer pot.
94. Install C21, another 10 μ F electrolytic capacitor, watch polarity.
95. Install R13, 1K ohm [brown-black-red].
96. Install R22, 10K ohm [brown-black-orange].
97. Install R29, 1K ohm [brown-black-red].

L4 is questionable! Leads not fitted properly

The following transistors are capable of higher power than the little guys you've been installing. Because of their higher power abilities, they will produce some heat and require a heat sink to carry the heat away from them. When installing these parts, the transistor sits on the metal heat sink and a 4-40 screw is passed through the transistor, heat sink and PC board, finally to be tightly fastened with a 4-40 nut.

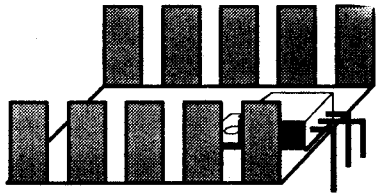

- 98. Install Q9, TO-220 style NPN power transistor [marked TIP31] as shown in the diagram. Use a 4-40 screw and nut to secure. Solder all three leads.
- 99. Install Q3, MTP-3055 power FET in the same fashion as above.
- 100. Locate D3, the red LED, notice that one of its leads is longer than the other. Install D3 into the PC board leaving its leads at full length. The longer lead goes into the PC board hole nearest the DIP switch. If installed incorrectly, D3 will not light. D3 will later be fitted through the front panel, so long leads are necessary.

What about those extra parts !!!!! This completes the assembly of your transmitter except for the low pass filter parts that are dependent upon the frequency you choose to operate on.

AM-25 Final Assembly Instructions

You'll need to determine what frequency you wish to set your transmitter to. It really is not sufficient to just "check" the AM band for an empty frequency, using the AM radio closest at hand. It is your responsibility to research what AM stations can be listened to in your area and not to interfere with any of your neighbors in their reception of **any** commercially licensed broadcast station. Usually a modern car radio (with external antenna) is extremely sensitive and a good indicator of what stations will be received in your area.

Once you have determined what your operating frequency will be, refer to the following chart for the correct values of C3,4,5,7 and L1,2,3. The inductors will be wound using the remaining enameled magnet wire. If you decide to change frequency at a later time, you can get more wire at any electronics store or Radio Shack. The size is not vitally important, just as long as you can fit all the windings on the core.

- 93. Consult the frequency chart on the following page and install the correct values for C3,4,5 and 7.
- 94. Winding the toroid inductors. Consult the frequency chart again and

Maximum Frequency (KHz)	C3 and C7	L1 and L3 No. of turns	C4 and C5	L2 No. of turns	Band Jumper (H1) Jumper pins
790	2200 pF	29	8200 pF	31	2 - 3
950	1500 pF	27	6800 pF	28	2 - 3
1150	1000 pF	25	5600 pF	27	1 - 2
1350	470 pF	23	4700 pF	24	1 - 2
1710	none	20	3900 pF	21	1 - 2

determine the proper number of turns for each inductor. Notice that L1 and L3 both have the same number of turns.

95. Using the formula below, cut proper lengths of magnet wire.

Length required = Number of turns x 0.6 inches.
 For example: 35 turns required. $35 \times 0.6" = 21"$

96. Wind the toroid cores, L1, 2 and 3 with the proper number of turns. One pass through the core counts as one turn. Leave each end 1/2" long and tin each end.
97. Install L1, 2 and 3. The inductors stand upright, there is no need to secure them unless you will be subjecting your kit to vibration. In that case you can use a dab of glue to hold each inductor.

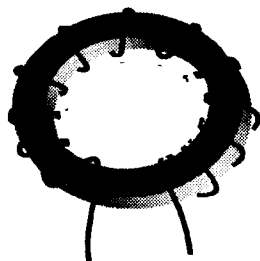

98. Referencing the frequency table, Plug the jumper block over the proper pin numbers on Header block H1.

You have just completed your AM-25 wireless broadcast transmitter. Take a well deserved break now. Give your eyes a rest. When you return, be sure to check over your work on the entire circuit board. Energizing the circuit board with solder "bridges" or misplaced components can damage your kit.

ANTENNA CONSIDERATIONS

For many applications, a 5 - 6 foot wire antenna connected to the center pin of the "RF OUT" connector will produce satisfactory results.

Another simple but effective hint is to connect the chassis "ground" to a good earth ground (like a cold water pipe, etc.). Be sure, however, that the total length of the antenna, feedline, and grounding wire is less than 10 feet as required by the FCC Part 15 rules.

Once you check the PC board for any errors and hook-up some sort of antenna, it's time to program in your frequency and align your transmitter.

PROGRAMMING YOUR AM-25

Programming your AM-25 is very easy, involving nothing more than dividing (by 10!) and subtraction. The output frequency in KHz is divided by 10 and this 'Program' number is then set on DIP switch, S1. These switches are programmed in Binary, you simply add up the closed switch positions: 1, 2, 4, 8 all the way up to 128 to make any 'Program' number between 0 and 255. Next to the DIP switch, there are numbers printed on the PC board from 1 to 128. For the AM broadcast band, 540 - 1710 KHz, we'll only need to program between 54 and 171. For example, if a broadcast frequency of 550 KHz is desired, we'll need a 'Program' number of 55 (550 KHz divided by 10 equals 55). Closing switches 32, 16, 4, 2 and 1 all adds up to 55, our desired 'Program' number. As another example, what would we need for 1520 KHz? Our desired program number is 152 (1520 KHz divided by 10 equals 152) and we'll have to close switches 128, 16, and 8 which adds up to 152! Another example: 930 KHz, 'Program' number is 93 (930 KHz divided by 10 = 93). Close switches 64, 16, 8, 4, 1. How about another? 1460 KHz, program number is 146, close switched 128, 16, and 2. A calculator comes in handy when you successively subtract the binary numbers (128, 64,...4,2,1). It really is quite easy and fun to find the right switches to close!

ALIGNMENT PROCEDURES

Keep all tests very brief until you have carefully chosen an open operating frequency in the AM broadcast band.

1. Find a quiet spot on the dial where you wish to receive your transmitter and tune a nearby radio to that frequency.
2. Connect an antenna to the RF OUT jack.
3. Program in your desired operating frequency.
4. Verify that you have installed the correct components in the low pass filter section (C3,4,5,7 and L1,2,3) and the jumper block is in the correct position on Header block H1.

- 5. Set trimmer pots R23 and R31 to mid-rotation.
- 6. Connect a power source capable of 12 VDC at 500 mA.
- 7. Measure the voltage on resistor R34's lead closest to C23. R34 is located between the heatsinks. Adjust 'Bias' pot R23 for 4.5 VDC.
- 8. Measure the voltage at TP1, located near the center of the board.
- 9. Using the plastic tuning tool, adjust coil L5 until you read approximately 3 volts DC at TP1. You should also see the red LED light up and be able to hear the AM-25's carrier signal.
- 10. Connect a 1 volt peak-to-peak audio source to the AUDIO IN jack. Adjust 'Audio level' pot R31 for best sounding undistorted audio. The best audio source for testing is the line level outputs of a tape deck or CD player. Most stereo systems have a line level output jack.
- 11. Adjusted as indicated, your AM-25 will produce 100 mW of RF power which conforms with the FCC rule of 100 mW. If you live outside of the USA, you may jumper across resistors R33 and R34 to allow the AM-25 to generate 1 watt of RF power.

TROUBLESHOOTING INSTRUCTIONS

While we had hoped that it wouldn't come to this, if you are having trouble with your transmitter, here are a few suggestions.

By far the most common source of problems is due to misplaced parts or poor solder connections. It's always best to take a break before searching for bad connections. Around here it's referred to as the "Irwin Time Test" which states that "anything left alone long enough seems to repair itself!" A good way of checking component placement is to double check the assembly steps going backwards from the last steps to the the first. Bright lighting and a magnifying aid can be helpful in identifying soldering problems.

Use a methodical, logical troubleshooting technique. Most problems can be solved using common sense. A volt-ohm meter and a clear head are usually all that are needed to correct any problem. Please understand that it is nearly impossible to "troubleshoot" by email or fax, phone is better. If you call, please have your kit in front of you and be sure it was assembled correctly.

PLEASE READ THIS IMPORTANT FCC INFORMATION

The AM-25 is classified by the FCC as an "intentional radiator," and its operation is covered by Part 15 of the FCC rules which were updated in June 1989. In brief, what you need to know about these rules is that your AM broadcaster must not interfere with AM radio or TV reception of other people. As designed and adjusted, the AM-25 complies with FCC technical

requirements for devices used in the AM broadcast band. The individual kit builder and all end users of this device assume responsibility for lawful uses conforming to the FCC part, 15 rules.

Operation is subject to the following conditions:

1. This device may not cause any harmful interference
2. This device must accept any interference received, including interference that may cause undesired operation.

These rules are published in 100 "Parts," covering anything imaginable concerning the topic of "Telecommunications." The six books containing the FCC rules are section 47 of the complete Code of Federal Regulations, which you are likely to find in the reference section of your local Public Library. If you have any legal questions concerning your AM-25 or any home built device which emits RF energy, it is your responsibility to study the FCC regulations. It is best if you personally read the rules (and consult with a lawyer if you're in doubt) and not bother understaffed and busy FCC employees with questions that are clearly answered in the rules. A sign on the side of one of magician David Copperfield's tour trucks comes to mind - "Only fools disturb sleeping tigers!"

Here are what we feel are the primary "do's and don'ts" picked from the current FCC rules, as of May, 1990. This is only a *brief* look at the rules and should not be construed to be the absolute complete legal interpretation! It is up to you to operate within the current Part 15 rules and Ramsey Electronics, Inc. cannot be held responsible for any violation thereof.

Licensed Broadcast stations and their listeners have all the rights! Your non-licensed use of any device such as the AM-25 has absolutely no rights at all over the rights of a licensed broadcast operator. If your operation of the AM-25 interferes with anyone's use or enjoyment of an FCC licensed transmission of any kind, your only choice is to immediately terminate or change the operation of your low power transmitter.

"On the Air" Etiquette

1. Do not use "made up" call signs to identify your transmissions. Only the FCC has the authority to grant such call signs. Use some other way to identify your transmitting activity, such as "This is radio 550, Pittsford School Student Radio," and so forth.
2. Identify the location and purpose of your transmissions from time to time. This is a common courtesy toward other persons who may hear your transmission. The FCC is toughest about clandestine transmission which costs time and money to track down.
3. If you are contacted by the FCC regarding the use of this device, cooperate fully and promptly.

4. If you receive any complaint about your transmissions interfering with broadcast reception, stop or change your operation immediately.

ANTENNA EXPERIMENTING

Since one wavelength (λ) at AM broadcast frequencies is over 950 feet, and a distance of only ten feet is allowed between the transmitter and antenna tip, you may want to experiment with a "loaded" antenna for better performance.

An easy way to describe what happens when you "load" the antenna is that we electrically increase the "length" of the antenna without increasing the mechanical length. Our goal is to approximate a functional portion of the full wavelength (i.e. $\lambda/4$ or $\lambda/8$)

Using an 8 foot length of wire, or an old 102" CB radio whip as the antenna, a series inductance of about 350 μH is required to properly load the circuit. We can use either a fixed inductor or wind our own loading coil, which is better! Ideally, we want a high-Q coil - which can be fabricated very easily using a 5 inch long piece of 1 1/2" diameter PVC pipe. Wind 120 turns of wire neatly spaced on the pipe. Drill a small hole in the pipe at each end and thread the wire through it a few times to hold it securely. Connect to the center pin of J1, the RCA output jack and connect the RCA connector shell to a good ground for maximum transmission range. The 8 foot length of wire should be extended vertically for maximum range.

Here's a neat antenna idea, the 1 1/2" PVC loading coil will fit nicely into 2" diameter PVC pipe. Get a 10 foot length, run the long antenna wire up through the pipe and over the edge a bit, slip a PVC pipe cap over the end to hold it in place. Slip the loading coil into the other end of the pipe and you've now got a neat waterproof antenna. And remember use a good ground for best transmission range. Have fun and happy broadcasting!

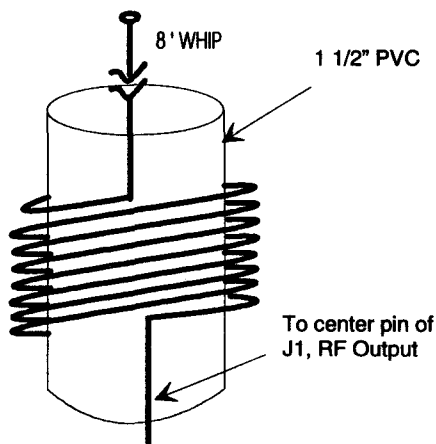

The Ramsey Kit Warranty

Please read carefully BEFORE calling or writing in about your kit. Most problems can be solved without contacting the factory.

Notice that this is not a "fine print" warranty. We want you to understand your rights and ours too! All Ramsey kits will work if assembled properly. The very fact that your kit includes this new manual is your assurance that a team of knowledgeable people have field-tested several "copies" of this kit straight from the Ramsey inventory. If you need help, please read through your manual carefully, all information required to properly build and test your kit is contained within the pages!

1. DEFECTIVE PARTS: It's always easy to blame a part for a problem in your kit. Before you conclude that a part may be bad, thoroughly check your work. Today's semiconductors and passive components have reached incredibly high reliability levels, and it's sad to say that our human construction skills have not! But on rare occasion a sour component can slip through. All our kit parts carry the Ramsey Electronics Warranty that they are free from defects for a full ninety (90) days from the date of purchase. Defective parts will be replaced promptly at our expense. If you suspect any part to be defective, please mail it to our factory for testing and replacement. Please send only the defective part(s), not the entire kit. The part(s) **MUST** be returned to us in suitable condition for testing. Please be aware that testing can usually determine if the part was truly defective or damaged by assembly or usage. Don't be afraid of telling us that you 'blew-it', we're all human and in most cases, replacement parts are very reasonably priced.

2. MISSING PARTS: Before assuming a part value is incorrect, check the parts listing carefully to see if it is a critical value such as a specific coil or IC, or whether a RANGE of values is suitable (such as "100 to 500 uF"). Often times, common sense will solve a mysterious missing part problem. If you're missing five 10K ohm resistors and received five extra 1K resistors, you can pretty much be assured that the "1K ohm" resistors are actually the "missing" 10 K parts ("Hum-m-m, I guess the 'red' band really does look orange!") Ramsey Electronics project kits are packed with pride in the USA. If you believe we packed an incorrect part or omitted a part clearly indicated in your assembly manual as supplied with the basic kit by Ramsey, please write or call us with information on the part you need and proof of kit purchase.

3. FACTORY REPAIR OF ASSEMBLED KITS:

To qualify for Ramsey Electronics factory repair, kits **MUST**:

1. NOT be assembled with acid core solder or flux.
2. NOT be modified in any manner.
3. BE returned in fully-assembled form, not partially assembled.
4. BE accompanied by the proper repair fee. No repair will be undertaken until we have received the MINIMUM repair fee (1/2 hour labor) of \$18.00, or authorization to charge it to your credit card account.
5. INCLUDE a description of the problem and legible return address. DO NOT send a separate letter; include all correspondence with the unit. Please do not include your own hardware such as non-Ramsey cabinets, knobs, cables, external battery packs and the like. Ramsey Electronics, Inc., reserves the right to refuse repair on ANY item in which we find excessive problems or damage due to construction methods. To assist customers in such situations, Ramsey Electronics, Inc., reserves the right to solve their needs on a case-by-case basis. The repair is \$36.00 per hour, regardless of the cost of the kit. Please understand that our technicians are not volunteers and that set-up, testing, diagnosis, repair and repacking and paperwork can take nearly an hour of paid employee time on even a simple kit. Of course, if we find that a part was defective in manufacture, there will be no charge to repair your kit (But please realize that our technicians know the difference between a defective part and parts burned out or damaged through improper use or assembly).
4. REFUNDS: You are given ten (10) days to examine our products. If you are not satisfied, you may return your unassembled kit with all the parts and instructions and proof of purchase to the factory for a full refund. The return package should be packed securely. Insurance is recommended. Please do not cause needless delays, read all information carefully.

AM-25 AM BROADCAST TRANSMITTER

Quick Reference Page Guide

Introduction to the AM-25	4
AM-25 Circuit Description	4
Schematic Diagram	7
Parts Layout Diagram	8
Parts List.....	9
Assembly Instructions.....	10
Frequency chart.....	18
Alignment Procedures	19
Troubleshooting	20
FCC Information	20
Antenna Experimenting	22
Ramsey Kit Warranty	23

REQUIRED TOOLS

- Soldering Iron (Radio Shack #RS64-2072)
- Thin Rosin Core Solder (RS64-025)
- Needle Nose Pliers (RS64-1844)
- Small Diagonal Cutters (RS64-1845)
- <OR> Complete Soldering Tool Set (RS64-2801)

ADDITIONAL SUGGESTED ITEMS

- Soldering Iron Holder/Cleaner (RS-64-2078)
- Holder for PC Board/Parts (RS64-2094)
- Desoldering Braid (RS-2090)

TOTAL SOLDER POINTS

99

ESTIMATED ASSEMBLY TIME

Beginner 4 hrs
Intermediate 2 hrs
Advanced 1.5 hr

Manual Price Only: \$5.00

Ramsey Publication No. MAM-25

Assembly and Instruction manual for:

RAMSEY MODEL NO. AM-25 SYNTHESIZED AM TRANSMITTER KIT

RAMSEY

RAMSEY ELECTRONICS, INC.
793 Canning Parkway
Victor, New York 14564
Phone (716) 924-4560

